



# 4LHA Series - HTP / DTP / STP

Engine Model	4LHA-HTP	4LHA-DTP	4LHA-STP	
Max. output at crankshaft*	kW [mhp]	113 [154] @3300 rpm	140 [190] @3300 rpm	169 [230] @3300 rpm
Max. output at crankshaft**	kW [mhp]	118 [160] @3300 rpm	147 [200] @3300 rpm	177 [240] @3300 rpm
Configuration	In-line, 4-stroke, vertical, water-cooled diesel engine			
No. of cylinders	4 cylinder			
Displacement	3.455 L [211 cu in]			
Bore x stroke	100 mm x 110 mm [3.94 in x 4.33 in]			
Aspiration	Turbocharged & intercooled			
Combustion system	Direct injection, VE rotary pump	Direct injection, in-line pump	Direct injection, in-line pump	
Starting system	Electric starting 12V - 2.5 kW			
Engine management	Mechanical			
Cooling system	Fresh water cooling by centrifugal fresh water pump Seawater cooling by rubber impeller seawater pump			
Alternator	12V - 80A			
Lubrication system	Enclosed, forced lubricating system			
Engine lube oil specifications	API class: CD or higher, SAE grade: 15W-40			
Direction of rotation at crankshaft	Counterclockwise viewed from stern			
Dry weight without gear	342 kg [754 lbs]	365 kg [805 lbs]	365 kg [805 lbs]	
Engine dimensions <sup>†</sup> L x W x H	1131 x 719 x 811 mm			
Emission compliance	EU RCD 1, BSO II, EMC			
Flywheel housing size	SAE #4			
Controls	Mechanical			

\* Fuel temperature 40°C at the inlet of the fuel injection pump [ISO 8665: 2006]

\*\* Fuel temperature 25°C at the inlet of the fuel injection pump (ISO 3046)

†Dimensions include KMH50A gearbox and L-type elbow (Dimensions may vary with other gears/elbow)

NOTE:

Fuel condition: Density at 15°C = 0.84 g/cm<sup>3</sup>; 1 kW = 1.3596 mhp = 1.3410 HP

Technical data is according to (ISO 8665)/(ISO 3046)

## DIMENSIONS

Rear view

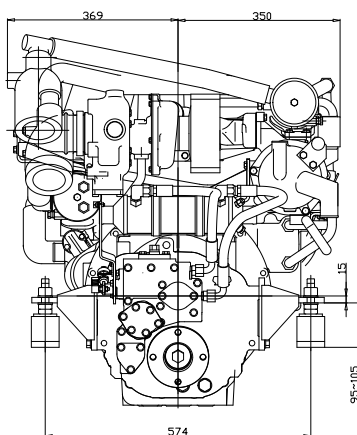

4LHA with KMH50A

(Not to be used for engine installation)

Right side view

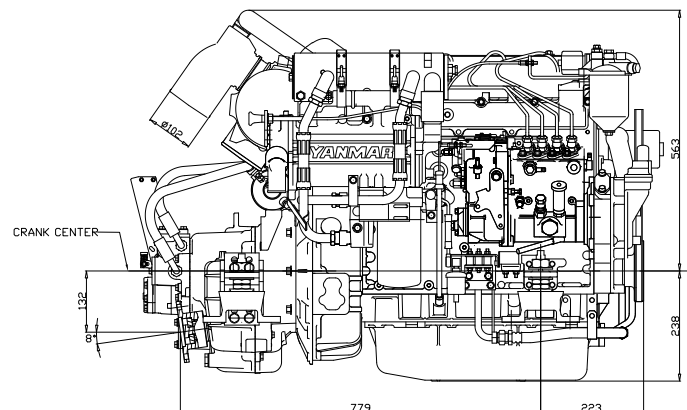



PERFORMANCE CURVES

4LHA-HTP Torque curve

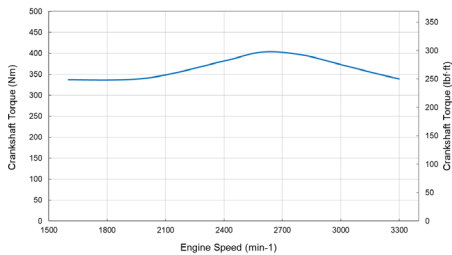

4LHA-HTP Output Power curve

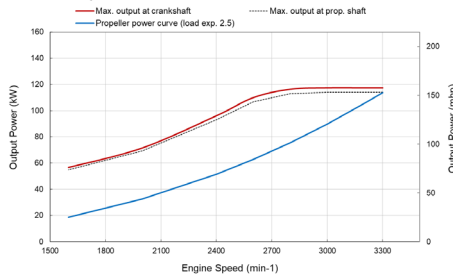

4LHA-HTP Fuel consumption (load exp. 2.5)

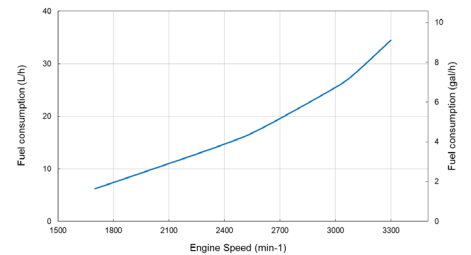

4LHA-DTP Torque curve

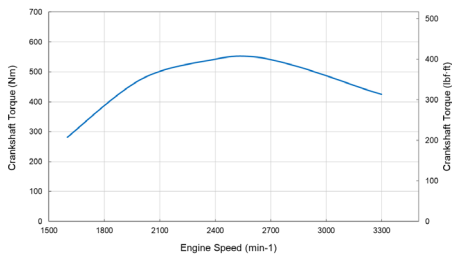

4LHA-DTP Output Power curve

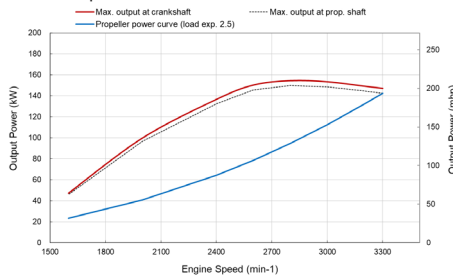

4LHA-DTP Fuel consumption (load exp. 2.5)

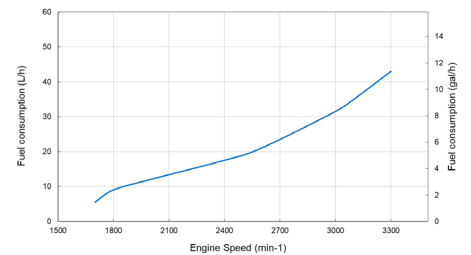

4LHA-STP Torque curve

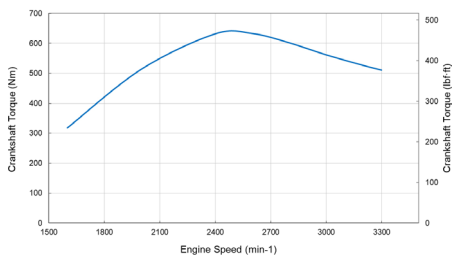

4LHA-STP Output Power curve

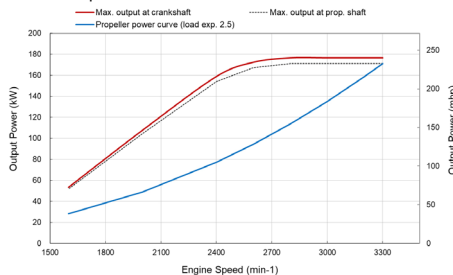

4LHA-STP Fuel consumption (load exp. 2.5)

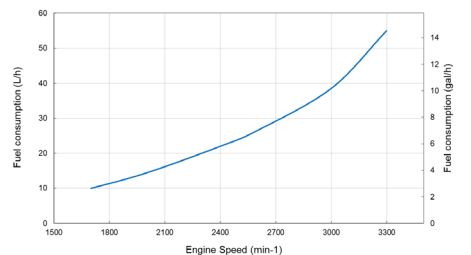

MARINE GEAR\*

Model	KMH50A-LH [down angle 8°]			KMH50V-LH [down angle 8°]			ZF63A [down angle 8°]			
Type	Hydraulic multi-disc			Hydraulic multi-disc			Hydraulic, wet multi-disc			
Dry weight	58** [128 lbs]			59 kg [130 lbs]			30 kg [66 lbs]			
Reduction ratio [fwd/asn]	1.67/1.67^^	2.13/2.13	2.43/2.43	1.22/1.22	1.58/1.58	2.08/2.08	1.22/1.22	1.56/1.56	2.04/2.04	2.54/2.54
Direction of rotation [viewed from stern]	Clockwise & counterclockwise			Clockwise & Counterclockwise			Clockwise & counter clockwise			
Lubrication system	Forced lubrication						Forced lubrication			
Lube oil specifications	API class: CF or higher, SAE grade: #30						ATF			
Max. lube oil capacity	1.8 L			5.4 L			4.0 L			
Dry weight - engine & gear	400 kg [882 lbs]			401 kg [884 lbs]			386 kg [851 lbs]			

\*For other configurations, consult your local Yanmar distributor.

\*\*Dry weight includes cooler and brackets

^^ KMH50A-LH (1.67 ratio) is not available as standalone supply & hence need to order with engine.

ACCESSORIES

**Standard engine package**

- Exhaust mixing elbow [L-type]
- Alternator 12V - 80A
- 3G instrument panel

**Optional accessories**

- High-riser mixing elbow [instead of L-elbow]
- Flexible mounts
- Extension wire harness [3m, 5m, 10m, 20m]
- SOLAS including Certificate [factory fit only]
- Air venting device for cooling water tank

- Lube oil evacuation pump
- Water separator
- Trolling valve [only for KMH50A]

NOTE: All data subject to change without notice. Text and illustrations are not binding.